

OVIVO

ELECTRIC

Light is Life



2023-2

FIYAT LİSTESİ

www.ovivoelektrik.com.tr

OVIVO
ELECTRIC

SANAL POS İLE E-Tahsilatta Hızlı Ödeme Farkını Yaşayın

tahsilat.ovivoelektrik.com.tr

Paraf

Garanti
bonus

bankKart
Combo

QNB
FINANSBANK

AXESS

maximum

VakıfBank
WORLD



Netahsilat altyapısı ve yazılımları uluslararası güvenlik standardı olan PCI DSS standartlarındadır. Kredi kartı bilgilerinin güvenliği için 256 Bit SSL kullanılmakta, ödeme ve tahsilat işlemleri 3D secure güvenlikle gerçekleştirilebilmektedir. Yazılımların çalıştığı donanımlar 3 katmanlı güvenlik sistemleriyle korunmakta ve 3 katmanlı yedekleme yapılmaktadır.

**“Yine bir ilk, yine bir yenilik,
yeni seri, çok yakında..”**

YENİ

QUANTUM

Sıva Altı Anahtar ve Priz Serisi



Tarzını yansıtır





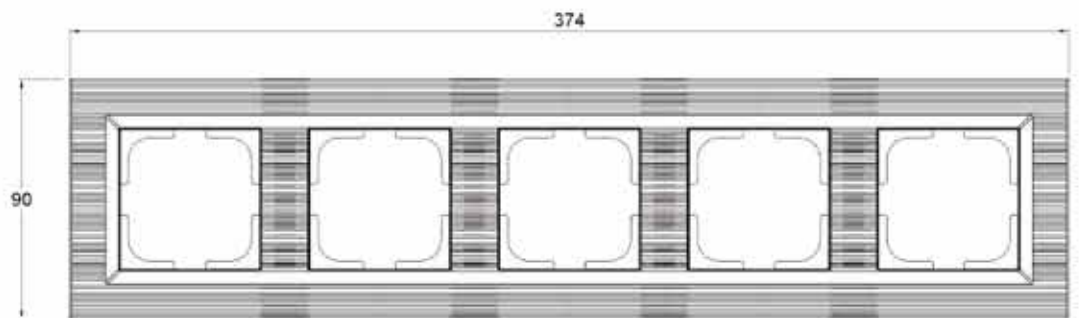
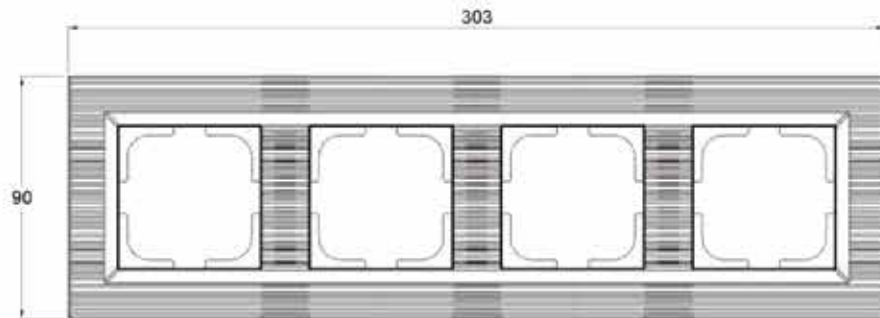
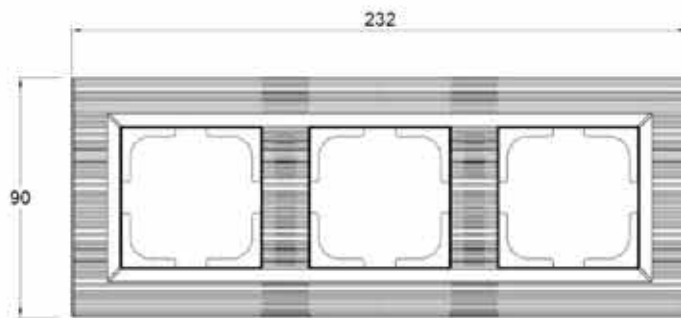
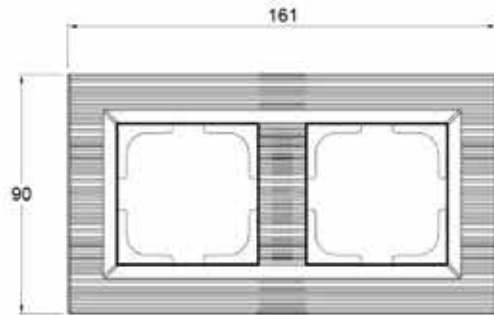
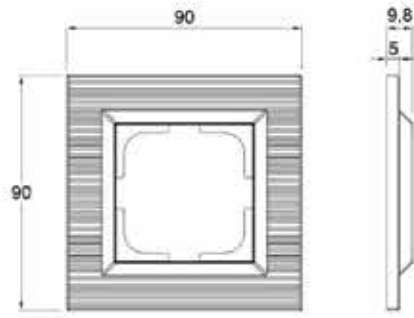

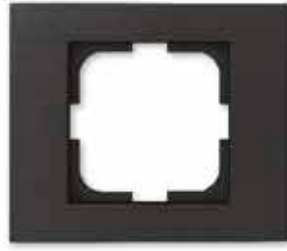

Grano Metallic - Tekli Çerçeve



Grano Metallic - Anahtar



Mina Metallic - Tekli Çerçeve



Mina Metallic - Anahtar



Loft Metallic - Tekli Çerçeve



Loft Metallic - Anahtar



Quantum - Tekli Çerçeve



Quantum - Anahtar



Elements - Tekli Çerçeve



Elements - Anahtar

YENİ

QUANTUM

Sıva Altı Anahtar ve Priz Serisi



Q46
ANTRASİT
405-350000-096

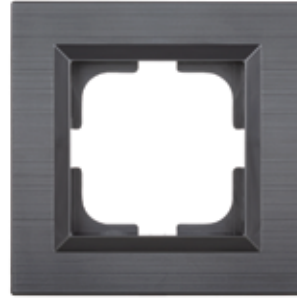

Q22
INOX
405-340000-096



Q04
MANYETİK GRİ
405-310000-096



Q03
METAL MAVİ
405-300000-096



Q02
GÜMÜŞ
405-320000-096



Q21
SİYAH
405-360000-096



Q24
BAKIR
405-330000-096

405-XX0000-096

XX - Üst çerçeve kodu karşılığı : 32=Gümüş, 30=Metal Mavi, 31=Manyetik Gri, 36=Siyah, 34=Inox, 33=Bakır, 35=Antrasit
Çoklu çerçeveler yatay ve dikey kullanıma uygundur.

Quantum serisi, (Mekanizma + Tuş / Kapak) ve (Çerçeve) şeklinde 2 parça olarak satılmaktadır.

YENİ

QUANTUM
İKİLİ TOPRAKLI ÇERÇEVE



Q46
ANTRASİT
405-350000-266



Q22
INOX
405-340000-266



Q04
MANYETİK GRİ
405-310000-266



Q03
METAL MAVİ
405-300000-266



Q02
GÜMÜŞ
405-320000-266



Q21
SİYAH
405-360000-266



Q24
BAKIR
405-330000-266

405-XX0000-266

XX - Üst çerçeve kodu karşılığı : 32=Gümüş, 30=Metal Mavi, 31=Manyetik Gri, 36=Siyah, 34=Inox, 33=Bakır, 35=Antrasit
Çoklu çerçeveler yatay ve dikey kullanıma uygundur.
Quantum serisi, (Mekanizma + Tuş / Kapak) ve (Çerçeve) şeklinde 2 parça olarak satılmaktadır.

YENİ

QUANTUM

Sıva Altı Anahtar ve Priz Serisi

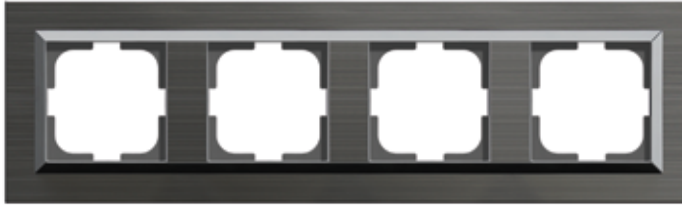

405-XX0000-096

XX - Üst çerçeve kodu karşılığı : 32=Gümüş, 30=Metal Mavi, 31=Manyetik Gri, 36=Siyah, 34=Inox, 33=Bakır, 35=Antrasit

Çoklu çerçeveler yatay ve dikey kullanıma uygundur.

Quantum serisi, (Mekanizma + Tuş / Kapak) ve (Çerçeve) şeklinde 2 parça olarak satılmaktadır.

Loft Natural



Mina Natural



Grano Natural



Quantum Natural



Çerçeve/Modül Sistemi

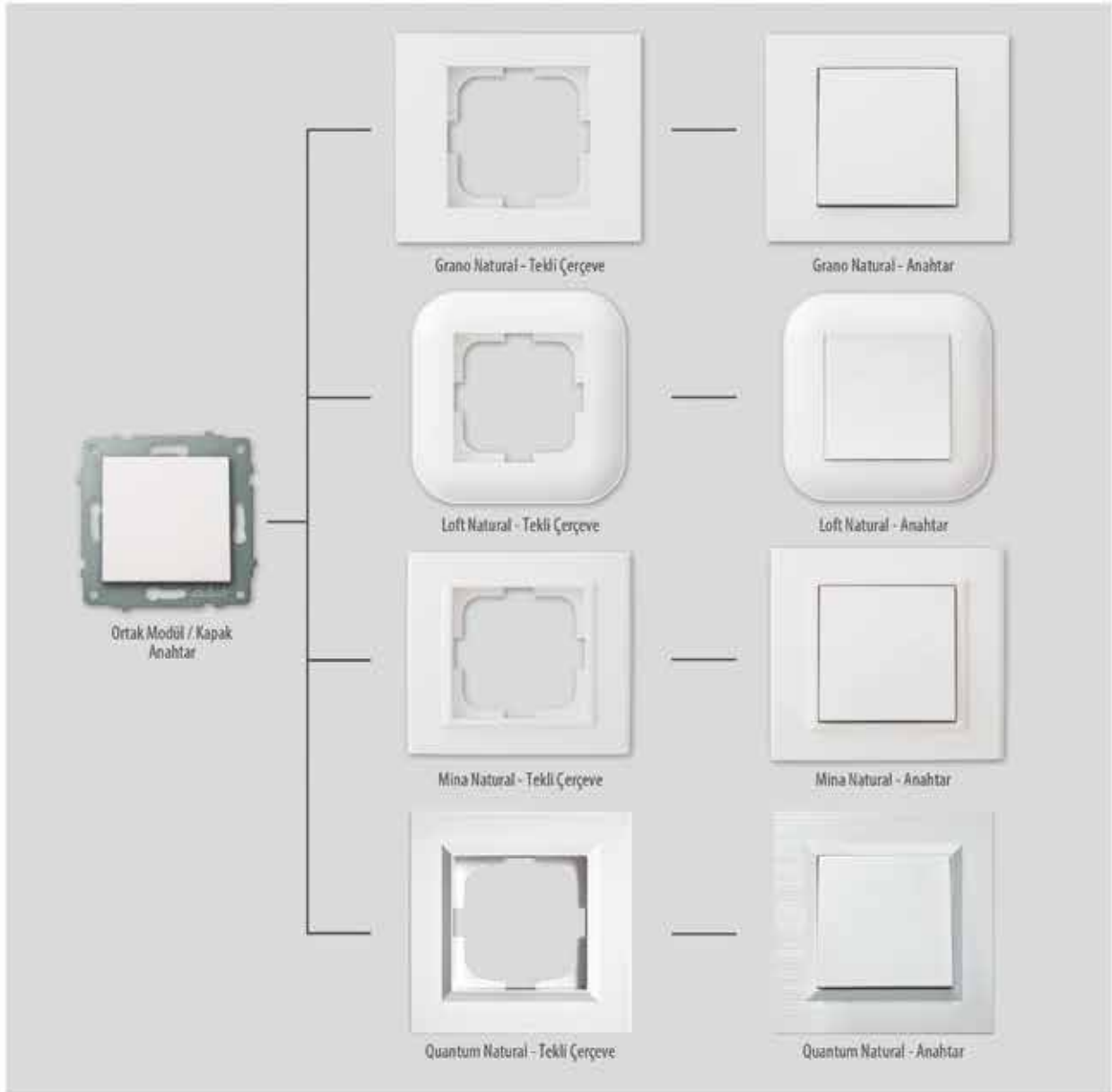

Kod Sistemi

Ürün kodlarındaki sayılar ne anlama gelir?

| Ürün Serisi Kodu | Çerçeve Çeşidi Kodu | Renk Kodu | Modül/Kapak Kodu |
|---|--------------------------------|--------------------------------------|--|
| 4 0 0 | 0 2 | | 2 0 0 |
| ▽ | ▽ | ▽ | ▽ |
| Grano Natural Loft Color Mina Metallic Quantum | Beyaz Krem Füme Mocha | Gri Kese Kağıdı Siyah Beyaz | Anahtar Topraklı Priz Numeris Priz Dimmer |

Grano Natural

Sıva Altı Anahtar ve Priz Serisi Renk ve Çerçeve Seçenekleri



Grano Natural / Beyaz / Anahtar



Grano Natural / Krem / Anahtar



Grano Natural Çerçeveler

| Referans No | Ürün Adı | Kutudaki Adet | Kolideki Adet | Liste Fiyatı (TL) |
|----------------|----------------|---------------|---------------|-------------------|
| 400-XX0000-096 | Tekli Çerçeve | 24 | 240 | 11,50 |
| 400-XX0000-226 | İkili Çerçeve | 12 | 120 | 82,50 |
| 400-XX0000-227 | Üçlü Çerçeve | 12 | 120 | 107,50 |
| 400-XX0000-228 | Dörtlü Çerçeve | 12 | 120 | 134,00 |
| 400-XX0000-250 | Beşli Çerçeve | 12 | 120 | 170,50 |
| 400-XX0000-251 | Altılı Çerçeve | 12 | 48 | 218,50 |

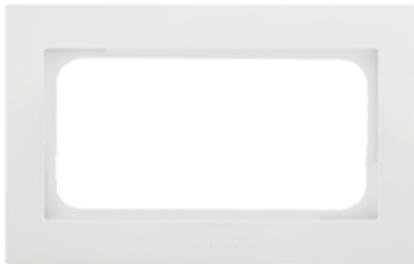

Grano Natural İkili Priz Çerçeveler

| Referans No | Ürün Adı | Kutudaki Adet | Kolideki Adet | Liste Fiyatı (TL) |
|----------------|--------------------|---------------|---------------|-------------------|
| 400-XX0000-266 | İkili Priz Çerçeve | 12 | 120 | 35,00 |

400-XX0000-096

XX - Çerçeve kodu karşılığı : 01 = Beyaz, 02 = Krem

Çoklu çerçeveler yatay ve dikey kullanıma uygundur. Grano serisi, (Mekanizma + Tuş / Kapak) ve (Çerçeve) şeklinde 2 parça olarak satılmaktadır.

Mina Natural

Sıva Altı Anahtar ve Priz Serisi Renk ve Çerçeve Seçenekleri



Mina Natural / Beyaz / Anahtar



Mina Natural / Krem / Anahtar



Mina Natural
Çerçeveler

| Referans No | Ürün Adı | Kutudaki Adet | Kolideki Adet | Liste Fiyatı (TL) |
|----------------|----------------|---------------|---------------|-------------------|
| 401-XX0000-096 | Tekli Çerçeve | 24 | 240 | 11,50 |
| 401-XX0000-226 | İkili Çerçeve | 12 | 120 | 82,00 |
| 401-XX0000-227 | Üçlü Çerçeve | 12 | 120 | 107,50 |
| 401-XX0000-228 | Dörtlü Çerçeve | 12 | 120 | 134,00 |
| 401-XX0000-250 | Beşli Çerçeve | 12 | 120 | 170,50 |

401-XX0000-096

XX - Çerçeve kodu karşılığı : 01 = Beyaz, 02 = Krem

Çoklu çerçeveler yatay ve dikey kullanıma uygundur. Mina serisi, (Mekanizma + Tuş / Kapak) ve (Çerçeve) şeklinde 2 parça olarak satılmaktadır.

Loft Natural

Sıva Altı Anahtar ve Priz Serisi Renk ve Çerçeve Seçenekleri



Loft Komb.
Beyaz - Gri / Anahtar



Loft Komb.
Beyaz - K.Kağıdı / Anahtar



Loft Komb.
Beyaz - Siyah / Anahtar



Loft Natural
Çerçeveler

| Referans No | Ürün Adı | Kutudaki Adet | Kolideki Adet | Liste Fiyatı (TL) |
|----------------|--------------------|---------------|---------------|---------------------|
| 404-XX00YY-096 | Tekli Çerçeve | 24 | 240 | 49,50 |
| 404-XX00YY-097 | Tekli Çerçeve Plus | 24 | 240 | 57,50 |
| 404-XX00YY-226 | İkili Çerçeve | 12 | 120 | 132,00 |
| 404-XX00YY-227 | Üçlü Çerçeve | 12 | 120 | 145,50 |
| 404-XX00YY-228 | Dörtlü Çerçeve | 12 | 120 | 187,50 |
| 404-XX00YY-250 | Beşli Çerçeve | 12 | 48 | 225,00 |

404-XX00YY-096

XX - Üst çerçeve kodu karşılığı : 01 = Beyaz, YY - Alt çerçeve kodu karşılığı : 03 = Koyu Gri, 06 = Kese Kağıdı, 08 = Siyah

Çoklu çerçeveler yatay ve dikey kullanıma uygundur. Loft serisi, (Mekanizma + Tuş / Kapak) ve (Çerçeve) şeklinde 2 parça olarak satılmaktadır.

Quantum Natural

Sıva Altı Anahtar ve Priz Serisi Renk ve Çerçeve Seçenekleri



Quantum Natural / Beyaz / Anahtar



Quantum Natural / Krem / Anahtar



Quantum Natural
Çerçeveler

| Referans No | Ürün Adı | Kutudaki Adet | Kolideki Adet | Liste Fiyatı (TL) |
|----------------|------------------------|---------------|---------------|---------------------|
| 405-XX0000-096 | Quantum Tekli Çerçeve | 24 | 240 | 49,50 |
| 405-XX0000-226 | Quantum İkili Çerçeve | 12 | 120 | 57,50 |
| 405-XX0000-227 | Quantum Üçlü Çerçeve | 12 | 120 | 132,00 |
| 405-XX0000-228 | Quantum Dörtlü Çerçeve | 12 | 120 | 145,50 |
| 405-XX0000-250 | Quantum Beşli Çerçeve | 12 | 120 | 187,50 |
| 405-XX0000-251 | Quantum Altılı Çerçeve | 12 | 120 | 225,00 |
| 405-XX0000-096 | Quantum Tekli Çerçeve | 24 | 240 | 49,50 |
| 405-XX0000-226 | Quantum İkili Çerçeve | 12 | 120 | 57,50 |
| 405-XX0000-227 | Quantum Üçlü Çerçeve | 12 | 120 | 132,00 |
| 405-XX0000-228 | Quantum Dörtlü Çerçeve | 12 | 120 | 145,50 |
| 405-XX0000-250 | Quantum Beşli Çerçeve | 12 | 120 | 187,50 |
| 405-XX0000-251 | Quantum Altılı Çerçeve | 12 | 120 | 225,00 |

405-XX0000-096

XX - Üst çerçeve kodu karşılığı : 01=Beyaz, 02=Krem

Çoklu çerçeveler yatay ve dikey kullanıma uygundur.

Quantum serisi, (Mekanizma + Tuş / Kapak) ve (Çerçeve) şeklinde 2 parça olarak satılmaktadır.

600-0002XX-200

XX - Kodu karşılığı : 01 = Beyaz, 02 = Krem

Anahtar, priz mekanizmalar, (Mekanizma + Tuş / Kapak) ve (Çerçeve) şeklinde 2 parça olarak satılmaktadır. Farklı "Energy Saver" çeşitleri için lütfen firmamız ile iletişime geçiniz.



Beyaz

600-000201-200



Krem

600-000202-200

NATURAL MEKANİZMA
FİYATLARI

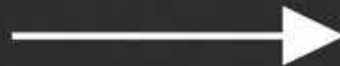

| Referans No | Ürün Adı (Mekanizma + Tuz/Kapak) | Kutudaki Adet | Kolideki Adet | Liste Fiyatı (TL) |
|----------------|----------------------------------|---------------|---------------|-------------------|
| 600-0002XX-200 | Anahtar | 12 | 120 | 85,50 |
| 600-0002XX-202 | Komütatör | 12 | 120 | 115,00 |
| 600-0002XX-205 | Light Anahtar | 12 | 120 | 100,50 |
| 600-0002XX-204 | Kapı Otomatığı Anahtar | 12 | 120 | 100,50 |
| 600-0002XX-207 | Zil Anahtar | 12 | 120 | 100,50 |
| 600-0002XX-209 | Veavien | 12 | 120 | 115,50 |
| 600-0002XX-211 | Komütatör Veavien | 12 | 120 | 172,50 |
| 600-0002XX-214 | Permütatör (Ara Veavien) | 12 | 120 | 164,00 |
| 600-0002XX-254 | Üçlü Anahtar | 12 | 120 | 159,00 |
| 600-0002XX-216 | Jaluzi Kumanda Anahtar | 12 | 120 | 199,00 |
| 600-0022XX-216 | Yaysız Jaluzi Kumanda Anahtar | 12 | 120 | 210,50 |
| 600-0002XX-220 | İmpuls Komütatör (Light + Light) | 12 | 120 | 193,00 |
| 600-0002XX-251 | DND/MUR İç Ünite Komütatör | 12 | 120 | 203,50 |
| 600-0002XX-252 | Müzik Yayın Anahtar | 12 | 120 | 1065,00 |

Led Işıklı Anahtar

| | | | | |
|----------------|----------------------|----|----|--------|
| 600-0002XX-201 | Işıklı Anahtar | 12 | 60 | 170,00 |
| 600-0002XX-203 | Işıklı Komütatör | 12 | 60 | 193,50 |
| 600-0002XX-206 | Işıklı Light Anahtar | 12 | 60 | 170,00 |
| 600-0002XX-210 | Işıklı Veavien | 12 | 60 | 184,00 |

Slim Anahtar Grubu

| | | | | |
|----------------|----------------------------------|----|-----|--------|
| 610-0002XX-200 | Anahtar | 12 | 120 | 112,50 |
| 610-0002XX-202 | Komütatör | 12 | 120 | 151,00 |
| 610-0002XX-205 | Light Anahtar | 12 | 120 | 127,50 |
| 610-0002XX-204 | Kapı Otomatığı Anahtar | 12 | 120 | 127,50 |
| 610-0002XX-207 | Zil Anahtar | 12 | 120 | 127,50 |
| 610-0002XX-209 | Veavien | 12 | 120 | 145,00 |
| 610-0002XX-211 | Komütatör Veavien | 12 | 60 | 197,00 |
| 610-0002XX-254 | Üçlü Anahtar | 12 | 60 | 195,00 |
| 610-0002XX-216 | Jaluzi Kumanda Anahtar | 12 | 60 | 251,50 |
| 610-0002XX-214 | Permütatör (Ara Veavien) | 12 | 60 | 187,00 |
| 610-0002XX-220 | İmpuls Komütatör (Light + Light) | 12 | 60 | 193,00 |

Priz Grubu

| | | | | |
|----------------|------------------------------|----|-----|----------|
| 600-0003XX-217 | Topraklı Priz | 12 | 120 | 115,50 |
| 600-0003XX-218 | Topraklı Priz | 12 | 120 | 156,50 |
| 600-0003XX-249 | Kapaklı Topraklı Priz | 12 | 120 | 153,50 |
| 600-0003XX-243 | Kapaklı Topraklı Priz | 12 | 120 | 175,00 |
| 600-0003XX-219 | Ups Topraklı Priz | 12 | 120 | 175,00 |
| 600-000301-907 | İkili Topraklı Priz | 12 | 72 | 185,50 |
| 600-0003XX-245 | 1X USB Şarj Prizi 5V-2A | 12 | 60 | 1.453,00 |
| 600-0003XX-247 | 2X USB Şarj Prizi 5V-2A | 12 | 60 | 1.723,00 |
| 400-XX0300-907 | Mina İkili Topraklı Priz | 12 | 72 | 202,50 |
| 600-0003XX-046 | Topraklı Priz (Usb + Type-C) | 12 | 120 | 1.150,00 |



Beyaz
600-000201-200



Krem
600-000202-200



Topraklı Priz (Usb + Type-C)
Beyaz (Çerçevesiz)
400-000301-046

| Referans No | Ürün Adı (Mekanizma + Tug/Kapak) | Kutudaki Adet | Kolideki Adet | Liste Fiyatı (TL) |
|---------------------------------|---|---------------|---------------|---------------------|
| TV - Uydu - Sat Prizleri | | | | |
| 600-0003XX-237 | TV Anten Prizi (Ekranlı Geçişli) | 12 | 120 | 183,50 |
| 600-0003XX-238 | TV Anten Prizi (Ekranlı Sonlu) | 12 | 120 | 183,50 |
| 600-0003XX-231 | Uydu Prizi (Tekli, F Tipi Konnektör, Sonlu) | 12 | 120 | 146,50 |
| 600-0003XX-232 | Uydu Prizi (Tekli, F Tipi Konnektör, Ekranlı) | 12 | 120 | 283,00 |
| 600-0003XX-239 | TV - Sat Prizi, İkili (Geçişli) | 12 | 60 | 796,00 |
| 600-0003XX-240 | TV - Sat Prizi, İkili (Sonlu) | 12 | 60 | 796,00 |
| 600-0003XX-241 | Kablo Çıkışı | 12 | 60 | 95,50 |

İletişim Priz Grubu

| | | | | |
|----------------|--|----|-----|----------|
| 600-0003XX-221 | Nümeris Telefon Prizi (1* RJ11-623 Kablolu , 4 Kontaklı) | 12 | 120 | 140,50 |
| 600-0003XX-223 | Nümeris Telefon Prizi (1* RJ11 - Cat 3 Kablosuz) | 12 | 120 | 172,50 |
| 600-0003XX-222 | İkili Nümeris Telefon Prizi (2* RJ11 - Cat 3) | 12 | 120 | 253,50 |
| 600-0003XX-234 | Data + Nümeris (Cat 6 + RJ11 Cat 3) | 12 | 120 | 446,50 |
| 600-0003XX-229 | Tekli Data Prizi (1* RJ45 Cat6) | 12 | 120 | 369,00 |
| 600-0003XX-230 | İkili Data Prizi (2* RJ45 Cat6) | 12 | 120 | 635,00 |
| 600-0003XX-233 | Data Priz (Jaksız) | 12 | 120 | 122,50 |
| 600-0003XX-236 | 1X HDMI Prizi | 12 | 120 | 705,50 |
| 600-0003XX-269 | 2XHDMI Prizi | 12 | 120 | 1.058,00 |
| 600-0003XX-242 | Data + HDMI Prizi | 12 | 120 | 1.252,00 |
| 600-0003XX-244 | Data + USB Data Prizi | 12 | 120 | 1.149,00 |
| 600-0003XX-255 | 1XFiber Optik | 12 | 120 | 296,00 |
| 600-0003XX-270 | 2XFiber Optik | 12 | 120 | 443,50 |
| 600-0003XX-235 | USB Data Prizi | 12 | 120 | 419,00 |

Dimmerler

| | | | | |
|----------------|-------------------------|----|-----|----------|
| 600-0003XX-212 | Dimmer 800W | 12 | 120 | 1.261,00 |
| 600-0003XX-248 | Dimmer 500W (Veavien) | 12 | 120 | 2.037,50 |

Elektronik Ürünler

| | | | | |
|----------------|-------------------------------------|----|-----|----------|
| 600-0003XX-262 | Energy Saver Mikro Switch Gecikmeli | 12 | 120 | 2.143,50 |
| 600-0003XX-263 | Energy Saver Mikro Switch | 12 | 120 | 1.310,00 |
| 200-000100-007 | 11 Pinli 3x10 A Röle | 12 | 120 | 3.770,00 |
| 120-011803-101 | Yan Çizgili Logosuz PVC Kart | 12 | 120 | 278,50 |

YENİ

QUANTUM



QUANTUM
ÇERÇEVE

| Referans No | Ürün Adı | Kutudaki Adet | Kolideki Adet | Liste Fiyatı (TL) |
|----------------|----------------|---------------|---------------|---------------------|
| 405-XX0000-096 | Tekli Çerçeve | 24 | 240 | 88,50 |
| 405-XX0000-226 | İkili Çerçeve | 12 | 120 | 169,00 |
| 405-XX0000-227 | Üçlü Çerçeve | 12 | 120 | 247,00 |
| 405-XX0000-228 | Dörtlü Çerçeve | 12 | 120 | 328,50 |
| 405-XX0000-250 | Beşli Çerçeve | 12 | 120 | 407,00 |
| 405-XX0000-251 | Altılı Çerçeve | 12 | 120 | 515,50 |



QUANTUM
İKİLİ PRİZ ÇERÇEVE

| Referans No | Ürün Adı | Kutudaki Adet | Kolideki Adet | Liste Fiyatı (TL) |
|----------------|--------------------|---------------|---------------|---------------------|
| 405-XX0000-266 | İkili Priz Çerçeve | 12 | 120 | 151,00 |

405-XX0000-096

XX - Üst çerçeve kodu karşılığı : 32=Gümüş, 30=Metal Mavi, 31=Manyetik Gri, 36=Siyah, 34=Inox, 33=Bakır, 35=Antrasit

Çoklu çerçeveler yatay ve dikey kullanıma uygundur.

Quantum serisi, (Mekanizma + Tuş / Kapak) ve (Çerçeve) şeklinde 2 parça olarak satılmaktadır.

Grano Metallic Çerçeve

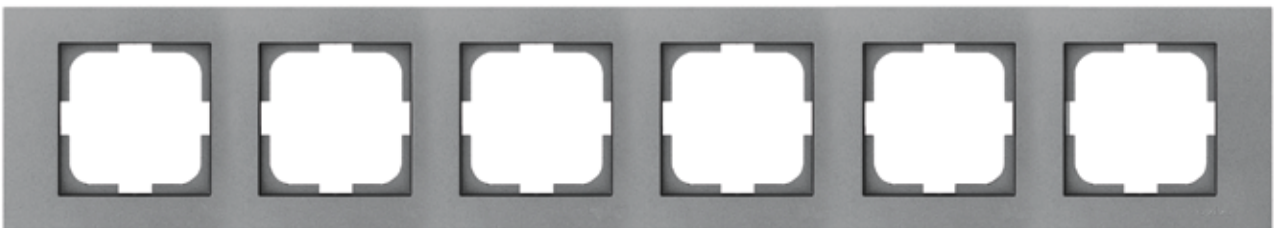
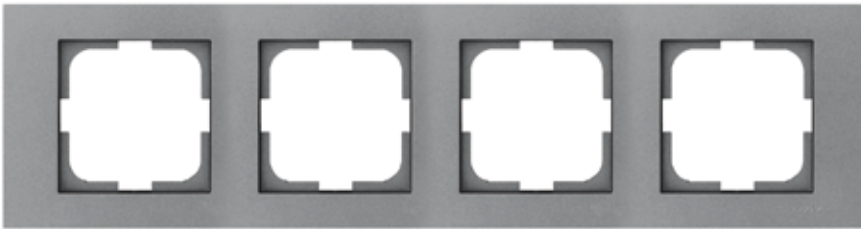
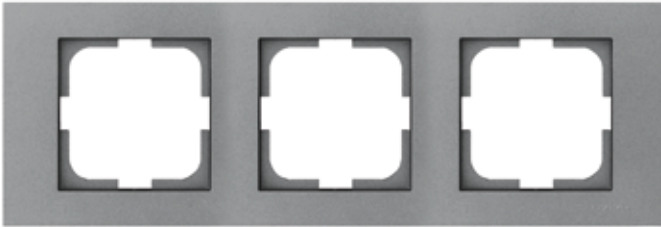
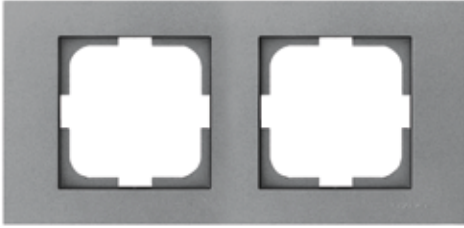
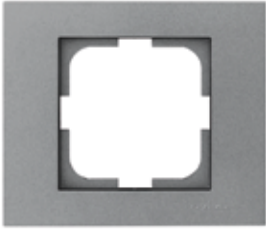

400-XX0000-096

XX - Çerçeve kodu karşılığı : 10 = Silver, 11 = Füme, 12 = Titanyum, 13 = Antrasit, 17 = Metalik Şiye, 18 = Mocha

Çoklu çerçeveler yatay ve dikey kullanıma uygundur. Mina serisi, (Mekanizma + Tuş / Kapak) ve (Çerçeve) şeklinde 2 parça olarak satılmaktadır.

Grano Metallic

Sıva Altı Anahtar ve Priz Serisi Renk ve Çerçeve Seçenekleri



Grano Metallic / Siyah



Grano Metallic / Füme



Grano Metallic / Antrasit



Grano Metallic / Titanyum



Grano Metallic / Gümüş

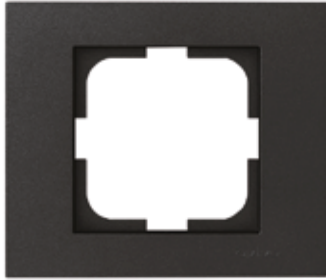

Grano Metallic Çerçeveler



Grano Metallic / Mocha

| Referans No | Ürün Adı | Kutudaki Adet | Kolideki Adet | Liste Fiyatı (TL) |
|----------------|----------------|---------------|---------------|-------------------|
| 400-XX0000-096 | Tekli Çerçeve | 24 | 240 | 50,00 |
| 400-XX0000-226 | İkili Çerçeve | 12 | 120 | 115,50 |
| 400-XX0000-227 | Üçlü Çerçeve | 12 | 120 | 169,00 |
| 400-XX0000-228 | Dörtlü Çerçeve | 12 | 120 | 221,00 |
| 400-XX0000-250 | Beşli Çerçeve | 12 | 120 | 276,00 |
| 400-XX0000-251 | Altılı Çerçeve | 12 | 48 | 334,50 |



Grano Metallic İkili Priz Çerçeveler

| Referans No | Ürün Adı | Kutudaki Adet | Kolideki Adet | Liste Fiyatı (TL) |
|----------------|--------------------|---------------|---------------|-------------------|
| 400-XX0000-266 | İkili Priz Çerçeve | 12 | 120 | 64,00 |

400-XX0000-096

XX - Çerçeve kodu karşılığı : 10 = Silver, 11 = Füme, 12 = Titanyum, 13 = Antrasit, 17 = Metalik Siyah, 19 = Mocha

Çoklu çerçeveler yatay ve dikey kullanıma uygundur. Mina serisi, (Mekanizma + Tuş / Kapak) ve (Çerçeve) şeklinde 2 parça olarak satılmaktadır.

Mina Metallic Çerçeve

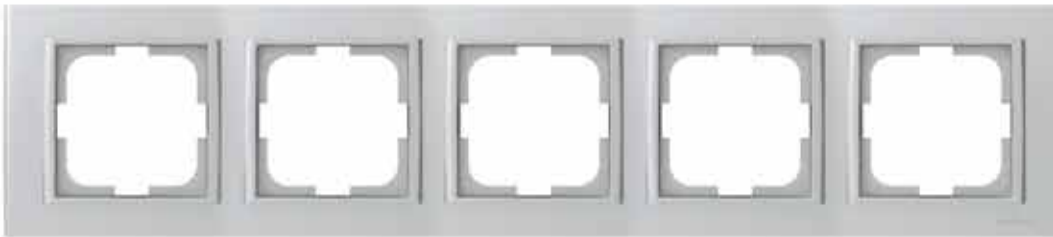
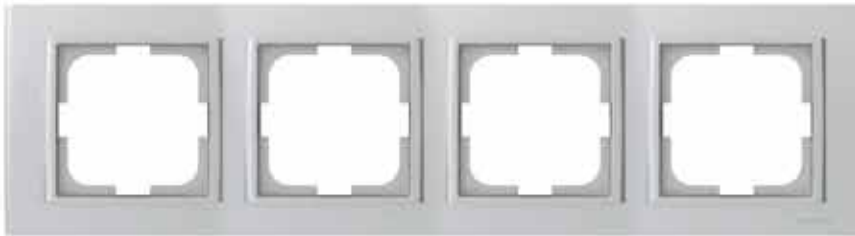
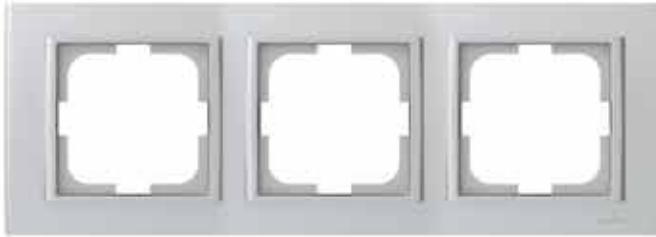
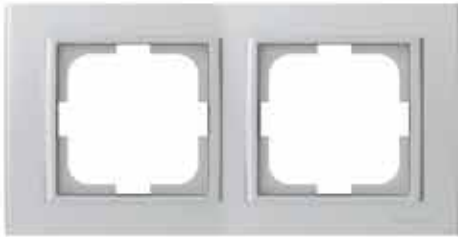

40I-XX0000-096

XX - Çerçeve kodu karşılığı : 10 = Silver, 11 = Füme, 12 = Titanyum, 13 = Antrasit, 17 = Metalik Siyah

Çoklu çerçeveler yatay ve dikey kullanıma uygundur. Mina serisi, (Mekanizma + Tuş / Kapak) ve (Çerçeve) şeklinde 2 parça olarak satılmaktadır.

Mina Metallic

Sıva Altı Anahtar ve Priz Serisi Renk ve Çerçeve Seçenekleri



Mina Metallic / Siyah

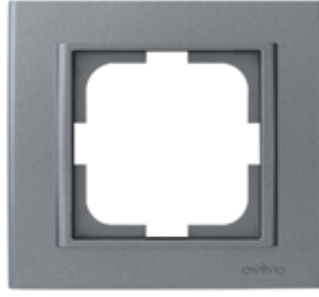

Mina Metallic / Füme



Mina Metallic / Antrasit



Mina Metallic / Titanyum



Mina Metallic / Gümüş



Mina Metallic Çerçeveler

| Referans No | Ürün Adı (Mekanizma + Tuş/Kapak) | Kutudaki Adet | Kolideki Adet | Liste Fiyatı (TL) |
|----------------|----------------------------------|---------------|---------------|-------------------|
| 401-XX0000-096 | Tekli Çerçeve | 24 | 240 | 50,00 |
| 401-XX0000-226 | İkili Çerçeve | 12 | 120 | 115,50 |
| 401-XX0000-227 | Üçlü Çerçeve | 12 | 120 | 169,00 |
| 401-XX0000-228 | Dörtlü Çerçeve | 12 | 120 | 221,50 |
| 401-XX0000-250 | Beşli Çerçeve | 12 | 120 | 276,00 |

401-XX0000-096

XX - Çerçeve kodu karşılığı : 10 = Silver, 11 = Füme, 12 = Titanyum, 13 = Antrasit, 17 = Metalik Siyah

Çoklu çerçeveler yatay ve dikey kullanıma uygundur. Mina serisi, (Mekanizma + Tuş / Kapak) ve (Çerçeve) şeklinde 2 parça olarak satılmaktadır.

Loft

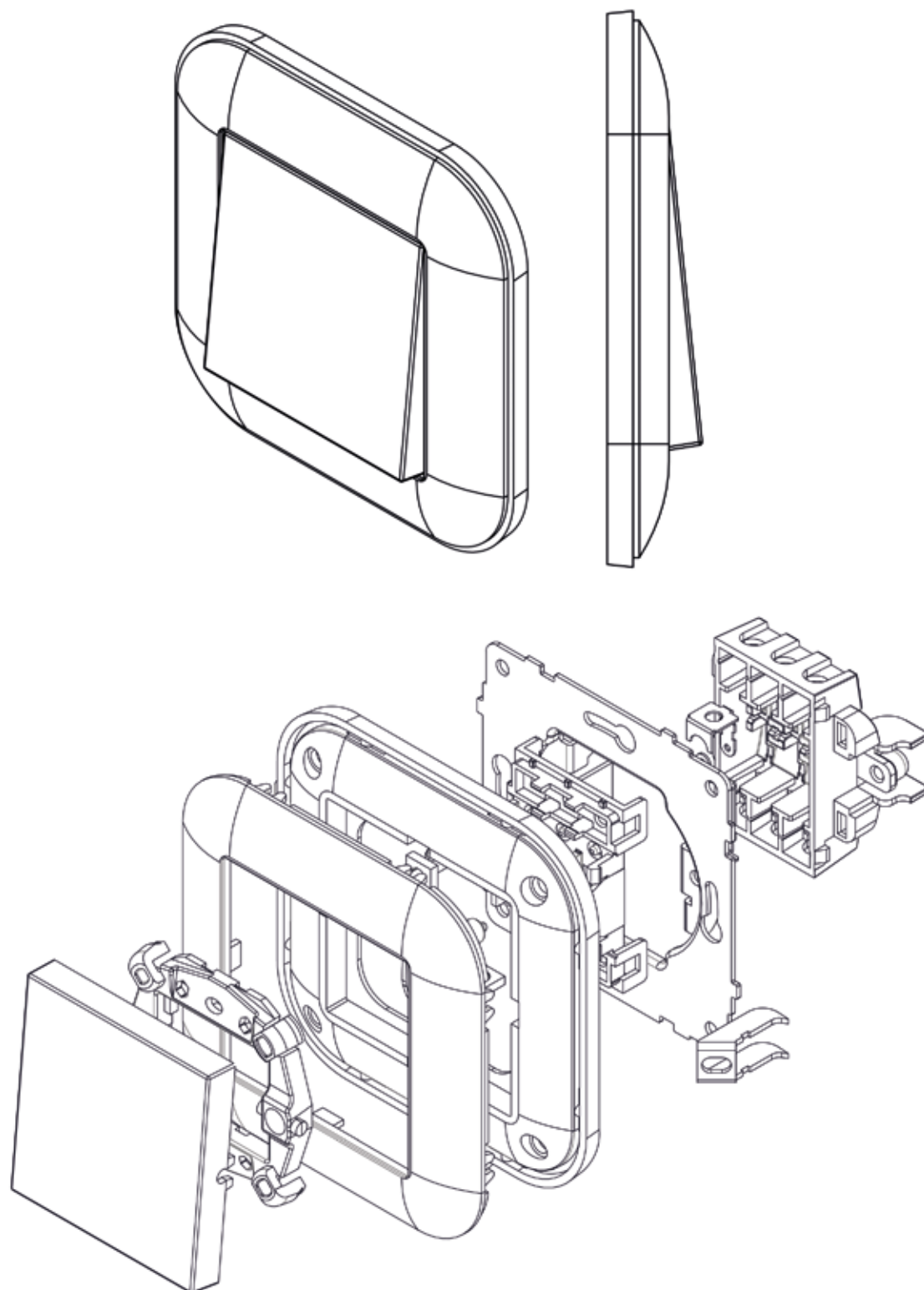

Loft Metallic

Sıva Altı Anahtar ve Priz Serisi Renk ve Çerçeve Seçenekleri



Loft Metallic / Siyah



Loft Metallic / FÜME



Loft Metallic / Antrasit



Loft Metallic / Mocha



Loft Metallic / Gümüş



Loft Metallic / M. Beyaz



Loft Metallic
Çerçeveler



Loft Metallic Plus Çerçeve

| Referans No | Ürün Adı (Mekanizma + Tuş/Kapak) | Kutudaki Adet | Kolideki Adet | Liste Fiyatı (TL) |
|----------------|----------------------------------|---------------|---------------|-------------------|
| 404-XX00YY-096 | Tekli Çerçeve | 24 | 240 | 72,50 |
| 404-XX00YY-097 | Tekli Çerçeve Plus | 24 | 240 | 83,00 |
| 404-XX00YY-226 | İkili Çerçeve | 12 | 120 | 165,50 |
| 404-XX00YY-227 | Üçlü Çerçeve | 12 | 120 | 233,50 |
| 404-XX00YY-228 | Dörtlü Çerçeve | 12 | 120 | 309,50 |
| 404-XX00YY-250 | Beşli Çerçeve | 12 | 120 | 385,00 |

404-XX00YY-096

XX - Üst çerçeve kodu karşılığı : 10 = Silver, 11 = FÜME, 13 = Antrasit, 17 = Metalik Siyah, 18 = Metalik Beyaz, 19 = Mocha

YY - Alt çerçeve kodu karşılığı : 10 = Silver, 11 = FÜME, 13 = Antrasit, 17 = Metalik Siyah, 18 = Metalik Beyaz, 19 = Mocha

Çoklu çerçeveler yatay ve dikey kullanıma uygundur. Loft serisi, (Mekanizma + Tuş / Kapak) ve (Çerçeve) şeklinde 2 parça olarak satılmaktadır.

Loft Chrome

Sıva Altı Anahtar ve Priz Serisi Renk ve Çerçeve Seçenekleri



Loft Chrome Çerçeveler

| Referans No | Ürün Adı (Mekanizma + Tuş/Kapak) | Kutudaki Adet | Kolideki Adet | Liste Fiyatı (TL) |
|----------------|----------------------------------|---------------|---------------|-------------------|
| 404-210017-096 | Tekli Çerçeve | 24 | 240 | 363,00 |
| 404-210017-097 | Tekli Çerçeve Plus | 24 | 240 | 833,00 |
| 404-210017-226 | İkili Çerçeve | 12 | 120 | 437,50 |
| 404-210017-227 | Üçlü Çerçeve | 12 | 120 | 691,00 |
| 404-210017-228 | Dörtlü Çerçeve | 12 | 120 | 1.224,00 |
| 404-210017-250 | Beşli Çerçeve | 12 | 120 | 1.427,00 |

Çoklu çerçeveler yatay ve dikey kullanıma uygundur.
Loft serisi, (Mekanizma + Tuş / Kapak) ve (Çerçeve) şeklinde 2 parça olarak satılmaktadır.

Elements Aluminium

Sıva Altı Anahtar ve Priz Serisi Renk ve Çerçeve Seçenekleri



Elements Aluminium
Siyah / Gümüş



Elements Aluminium
Gümüş / M. Siyah



Elements Aluminium
Bronz / M. Siyah



Alüminyum Çerçeveler

| Referans No | Ürün Adı (Mekanizma + Tuş/Kapak) | Kutudaki Adet | Kolideki Adet | Liste Fiyatı (TL) |
|----------------|----------------------------------|---------------|---------------|-------------------|
| 403-XX00YY-096 | Tekli Çerçeve | 6 | 240 | 651,50 |
| 403-XX00YY-226 | İkili Çerçeve | 6 | 120 | 1105,00 |
| 403-XX00YY-227 | Üçlü Çerçeve | 6 | 120 | 1.558,00 |
| 403-XX00YY-228 | Dörtlü Çerçeve | 6 | 120 | 2.010,50 |
| 403-XX00YY-250 | Beşli Çerçeve | 6 | 120 | 2.480,00 |

403-XX00YY-096

XX - Üst çerçeve kodu karşılığı : 50 = Siyah, 51 = Bronz, 52 = Gümüş. YY - Alt çerçeve kodu karşılığı : 10 = Silver, 17 = Metalik Siyah
Elements serisi, (Mekanizma + Tuş / Kapak) ve (Çerçeve) şeklinde 2 parça olarak satılmaktadır.

Elements Orient

Sıva Altı Anahtar ve Priz Serisi Renk ve Çerçeve Seçenekleri



Elements Orient
Krom / M. Siyah



Elements Orient
Füme / M. Siyah



Elements Orient
Inox / M. Siyah



Elements Orient
Altın / M. Siyah



Orient
Çerçeveler

| Referans No | Ürün Adı (Mekanizma + Tuş/Kapak) | Kutudaki Adet | Kolideki Adet | Liste Fiyatı (TL) |
|----------------|----------------------------------|---------------|---------------|-------------------|
| 403-XX0017-096 | Tekli Çerçeve | 6 | 240 | 750,00 |
| 403-XX0017-226 | İkili Çerçeve | 6 | 120 | 1.284,00 |
| 403-XX0017-227 | Üçlü Çerçeve | 6 | 120 | 1.705,00 |
| 403-XX0017-228 | Dörtlü Çerçeve | 6 | 120 | 2.063,50 |

403-XX0017-096

XX - Üst çerçeve kodu karşılığı : 80 = Füme, 81 = Altın, 82 = Krom, 83 = Inox,

Elements serisi, (Mekanizma + Tuş / Kapak) ve (Çerçeve) şeklinde 2 parça olarak satılmaktadır.

Elements Akrilik Cam

Sıva Altı Anahtar ve Priz Serisi Renk ve Çerçeve Seçenekleri

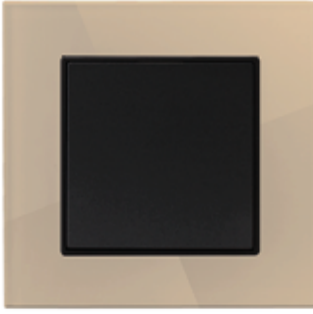

Elements Akrilik Cam
Kesekağıdı / M. Siyah

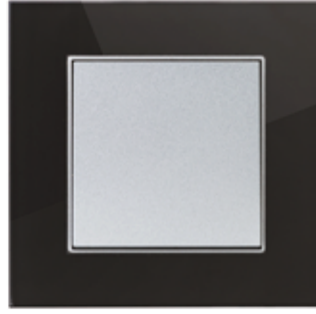

Elements Akrilik Cam
Siyah / M. Gümüş



Elements Akrilik Cam
Beyaz / M. Siyah

| Referans No | Ürün Adı (Mekanizma + Tuş/Kapak) | Kutudaki Adet | Kolideki Adet | Liste Fiyatı (TL) |
|----------------|----------------------------------|---------------|---------------|---------------------|
| 403-XX00YY-096 | Tekli Çerçeve | 6 | 240 | 506,00 |
| 403-XX00YY-226 | İkili Çerçeve | 6 | 120 | 921,50 |
| 403-XX00YY-227 | Üçlü Çerçeve | 6 | 120 | 1.330,50 |
| 403-XX00YY-228 | Dörtlü Çerçeve | 6 | 120 | 1.789,50 |
| 403-XX00YY-250 | Beşli Çerçeve | 6 | 120 | 2.268,00 |

403-XX00YY-096

XX - Üst çerçeve kodu karşılığı : 70 = Beyaz, 71 = Siyah, 72 = Kese Kağıdı. YY - Alt çerçeve kodu karşılığı : 10 = Silver, 17 = Metalik Siyah
Elements serisi, (Mekanizma + Tuş / Kapak) ve (Çerçeve) şeklinde 2 parça olarak satılmaktadır.



ELEMENTS MASIF AHŞAP



ELEMENTS CEVİZ AHŞAP

| Referans No | Ürün Adı (Mekanizma + Tuş/Kapak) | Kutudaki Adet | Kolideki Adet | Liste Fiyatı (TL) |
|----------------|----------------------------------|---------------|---------------|---------------------|
| 403-XX00YY-096 | Tekli Çerçeve | 6 | 240 | 710,00 |
| 403-XX00YY-226 | İkili Çerçeve | 6 | 120 | 1.236,50 |
| 403-XX00YY-227 | Üçlü Çerçeve | 6 | 120 | 1.762,50 |
| 403-XX00YY-228 | Dörtlü Çerçeve | 6 | 120 | 2.241,50 |
| 403-XX00YY-250 | Beşli Çerçeve | 6 | 120 | 2.698,00 |

403-XX00YY-096

XX - Üst çerçeve kodu karşılığı : 40 = Bambu, 41 = Sapelli

YY - Alt çerçeve kodu karşılığı : 10 = Silver, 17 = Metalik Siyah

Elements serisi, (Mekanizma + Tuş / Kapak) ve (Çerçeve) şeklinde 2 parça olarak satılmaktadır.

Anahtar Grubu



Anahtar
600-0002XX-200



Permütatör (Ara Veavien)
600-0002XX-214



Komütatör
600-0002XX-202



Üçlü Anahtar
600-0002XX-254



Light Anahtarı
600-0002XX-205



Jaluzi Kumanda Anahtarı
600-0002XX-216



Kapı Otomatığı Anahtarı
600-0002XX-204



Yaysız Jaluzi Kumanda Anahtarı
600-0022XX-216



Zil Anahtarı
600-0002XX-207



İmplus Komütatör (Light + Light)
600-0002XX-220



Veavien
600-0002XX-209



DND/MUR
600-0002XX-251



Komütatör Veavien
600-0002XX-211



Müzik Yayın Anahtarı
600-0002XX-252

Led Işıklı Anahtar Grubu



Işıklı Anahtar
600-0002XX-201



Light Anahtarı
610-0002XX-205



Işıklı Komütatör
600-0002XX-203



Kapı Otomatiği Anahtarı
610-0002XX-204



Işıklı Light Anahtarı
600-0002XX-206



Zil Anahtarı
610-0002XX-207



Işıklı Veavien
600-0002XX-210



Veavien
610-0002XX-209



Komütatör Veavien
610-0002XX-211

Slim Anahtar Grubu



Anahtar
610-0002XX-200



Üçlü Anahtar
610-0002XX-254



Komütatör
610-0002XX-202



Jaluzi Kumanda Anahtarı
610-0002XX-216

Priz Grubu



Topraklı Priz
600-0003XX-217



1X USB Şarj Prizi 5V-2A
600-0003XX-245



Topraklı Priz (Çocuk Korumalı)
600-0003XX-218



2X USB Şarj Prizi 5V-2A
600-0003XX-247



Kapaklı Topraklı Priz
600-0003XX-249

TV - Uydu - Sat Prizleri



Kapaklı Topraklı Priz (Çocuk Korumalı)
600-0003XX-243



TV Anten Prizi (Ekranlı Geçişli)
600-0003XX-237
TV Anten Prizi (Ekran Sonlu)
600-0003XX-238



Ups Topraklı Priz (Çocuk Korumalı)
600-0003XX-219



Uydu Prizi (Tekli, F Tipi Konnektör, Sonlu)
600-0003XX-231
Uydu Prizi (Tekli, F Tipi Konnektör, Ekranlı)
600-0003XX-232



İkili Topraklı Priz (Modül + Kapak)
600-0003XX-907



TV - Sat Prizi, İkili (Geçişli)
600-0003XX-239
TV - Sat Prizi, İkili (Geçişli)
600-0003XX-240



Kablo Çıkışı
600-0003XX-241

İletişim Priz Grubu



Nümeris Telefon Prizi
(1*RJ11-623 Kablolu, 4 Kontaklı)
600-0003XX-221



1X HDMI Prizi
600-0003XX-236
2X HDMI Prizi
600-0003XX-269



Nümeris Telefon Priz
(1*RJ11 - Cat 3 Kablosuz)
600-0003XX-223



USB Data Prizi
600-0003XX-235



İkili Nümeris Telefon Priz
(2*RJ11 - Cat 3)
600-0003XX-222



Data + HDMI Prizi
600-0003XX-242



Data + Nümeris
(Cat 6 + RJ11 Cat 3)
600-0003XX-234



Data + USB Data Prizi
600-0003XX-244



Tekli Data Prizi
(1*RJ45 Cat6)
600-0003XX-229



1X Fiber Optik
600-0003XX-255
2X Fiber Optik
600-0003XX-270



İkili Data Prizi
(2*RJ45 Cat6)
600-0003XX-230



Fiber Optik + HDMI Prizi
610-0002XX-254



Data Priz (Jaksız)
600-0003XX-233



Fiber Optik + Data Prizi
610-0002XX-216

Dimmerler



Dimmer 800W
600-0003XX-212
Dimmer 500W (Vavien)
600-0003XX-248



11 Pinli 3x10 A Röle
200-000100-007

Elektronik Ürünler



Energy Saver Mikro Switch (Gecikmeli)
600-0003XX-262
Energy Saver Mikro Switch
600-0003XX-263



TV - Sat Prizi, İkili (BOŞ KAPAK)



Metalik Siyah
600-000217-200



Metalik Beyaz
600-000218-200

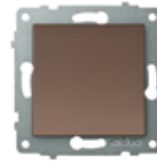

Mocha
600-000219-200



Silver
600-000210-200



Titanyum
600-000212-200



Füme
600-000211-200

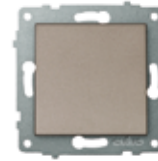

Antrasit
600-000213-200

600-0002XX-200

XX - Kodu karşılığı : 10 = Silver, 11 = Füme, 12 = Titanyum, 13 = Antrasit, 17 = Metalik Siyah, 18 = Metalik Beyaz, 19 = Mocha
Anahtar, priz mekanizmalar, (Mekanizma + Tuş / Kapak) ve (Çerçeve) şeklinde 2 parça olarak satılmaktadır.
Farklı "Energy Saver" çeşitleri için lütfen firmamız ile iletişime geçiniz.

600-0002XX-200

XX - Kodu karşılığı : 10 = Silver, 11 = Fme, 12 = Titanyum, 13 = Antrasit, 17 = Metalik Siyah, 18 = Metalik Beyaz, 19 = Mocha
Anahtar, priz mekanizmalar, (Mekanizma + Tuş / Kapak) ve (Çerçeve) şeklinde 2 parça olarak satılmaktadır.
Farklı "Energy Saver" çeşitleri için ltfen firmamız ile iletiřime geiniz.



Metalik Siyah
600-000217-200



Fme
600-000211-200



Titanyum
600-000212-200



Silver
600-000210-200

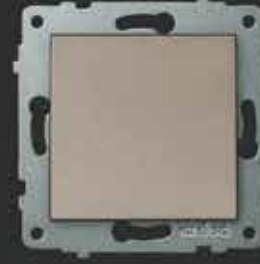

Antrasit
600-000213-200



Mocha
600-000219-200



Metalik Beyaz
600-000218-200

RENKLİ MEKANİZMA FİYATLARI



| Referans No | Ürün Adı (Mekanizma + Tuş/Kapak) | Kutudaki Adet | Kolideki Adet | Liste Fiyatı (TL) |
|----------------|----------------------------------|---------------|---------------|-------------------|
| 600-0002XX-200 | Anahtar | 12 | 120 | 124,00 |
| 600-0002XX-202 | Komütatör | 12 | 120 | 160,00 |
| 600-0002XX-205 | Light Anahtarı | 12 | 120 | 130,00 |
| 600-0002XX-204 | Kapı Otomatığı Anahtarı | 12 | 120 | 130,00 |
| 600-0002XX-207 | Zil Anahtarı | 12 | 120 | 130,00 |
| 600-0002XX-209 | Veavien | 12 | 120 | 153,00 |
| 600-0002XX-211 | Komütatör Veavien | 12 | 120 | 224,00 |
| 600-0002XX-214 | Permütatör (Ara Veavien) | 12 | 120 | 204,50 |
| 600-0002XX-254 | Üçlü Anahtar | 12 | 120 | 206,50 |
| 600-0002XX-216 | Jaluzi Kumanda Anahtarı | 12 | 120 | 249,00 |
| 600-0002XX-216 | Yaysız Jaluzi Kumanda Anahtarı | 12 | 120 | 261,00 |
| 600-0002XX-220 | İmpuls Komütatör (Light + Light) | 12 | 120 | 242,00 |
| 600-0002XX-251 | DND/MUR İç Ünite Komütatör | 12 | 120 | 254,50 |
| 600-0002XX-252 | Müzik Yayın Anahtarı | 12 | 120 | 1.385,00 |

Led Işıklı Anahtar

| | | | | |
|----------------|-----------------------|----|----|--------|
| 600-0002XX-201 | Işıklı Anahtar | 12 | 60 | 212,50 |
| 600-0002XX-203 | Işıklı Komütatör | 12 | 60 | 252,50 |
| 600-0002XX-206 | Işıklı Light Anahtarı | 12 | 60 | 112,50 |
| 600-0002XX-210 | Işıklı Veavien | 12 | 60 | 239,00 |

Slim Anahtar Grubu

| | | | | |
|----------------|----------------------------------|----|-----|--------|
| 610-0002XX-200 | Anahtar | 12 | 120 | 162,00 |
| 610-0002XX-202 | Komütatör | 12 | 120 | 203,50 |
| 610-0002XX-205 | Light Anahtarı | 12 | 120 | 161,00 |
| 610-0002XX-204 | Kapı Otomatığı Anahtarı | 12 | 120 | 161,00 |
| 610-0002XX-207 | Zil Anahtarı | 12 | 120 | 161,00 |
| 610-0002XX-209 | Veavien | 12 | 120 | 193,50 |
| 610-0002XX-211 | Komütatör Veavien | 12 | 60 | 238,50 |
| 610-0002XX-254 | Üçlü Anahtar | 12 | 60 | 229,50 |
| 610-0002XX-216 | Jaluzi Kumanda Anahtarı | 12 | 60 | 274,00 |
| 610-0002XX-214 | Permütatör (Ara Veavien) | 12 | 60 | 276,00 |
| 610-0002XX-220 | İmpuls Komütatör (Light + Light) | 12 | 60 | 267,00 |

Priz Grubu

| | | | | |
|----------------|---------------------------------------|----|-----|----------|
| 600-0003XX-217 | Topraklı Priz | 12 | 120 | 149,50 |
| 600-0003XX-218 | Topraklı Priz (Çerçevesiz) | 12 | 120 | 196,00 |
| 600-0003XX-249 | Kapaklı Topraklı Priz | 12 | 120 | 199,50 |
| 600-0003XX-243 | Kapaklı Topraklı Priz (Çerçevesiz) | 12 | 120 | 219,00 |
| 600-0003XX-219 | Ups Topraklı Priz (Çerçevesiz) | 12 | 120 | 231,00 |
| 600-000301-907 | İkili Topraklı Priz (Çerçevesiz) | 12 | 72 | 232,00 |
| 600-0003XX-245 | 1X USB Şarj Prizi 5V-2A | 12 | 60 | 1.816,00 |
| 600-0003XX-247 | 2X USB Şarj Prizi 5V-2A | 12 | 60 | 2.153,50 |
| 400-XX0300-907 | Mina İkili Topraklı Priz (Çerçevesiz) | 12 | 72 | 262,50 |
| 600-0003XX-046 | Topraklı Priz (Usb + Type-C) | 12 | 120 | 1.765,00 |



Topraklı Priz (Usb + Type-C)
Siyah (Çerçevesiz)
405-000336-046



Metalik Siyah
600-000217-200



Füme
600-000211-200



Titanyum
600-000212-200



Silver
600-000210-200



Antrasit
600-000213-200



Mocha
600-000219-200

| Referans No | Ürün Adı (Mekanizma + Tuş/Kapak) | Kutudaki Adet | Kolideki Adet | Liste Fiyatı (TL) |
|---------------------------------|---|---------------|---------------|-------------------|
| TV - Uydu - Sat Prizleri | | | | |
| 600-0003XX-237 | TV Anten Prizi (Ekranlı Geçişli) | 12 | 120 | 229,50 |
| 600-0003XX-238 | TV Anten Prizi (Ekranlı Sonlu) | 12 | 120 | 229,50 |
| 600-0003XX-231 | Uydu Prizi (Tekli, F Tipi Konnektör, Sonlu) | 12 | 120 | 184,00 |
| 600-0003XX-232 | Uydu Prizi (Tekli, F Tipi Konnektör, Ekranlı) | 12 | 120 | 368,50 |
| 600-0003XX-239 | TV - Sat Prizi, İkili (Geçişli) | 12 | 60 | 994,50 |
| 600-0003XX-240 | TV - Sat Prizi, İkili (Sonlu) | 12 | 60 | 994,50 |
| 600-0003XX-241 | Kablo Çıkışı | 12 | 60 | 129,00 |

İletişim Priz Grubu

| | | | | |
|----------------|---|----|-----|----------|
| 600-0003XX-221 | Nümeris Telefon Prizi (1*RJ11-623 Kablolu , 4 Kontaklı) | 12 | 120 | 182,50 |
| 600-0003XX-223 | Nümeris Telefon Priz (1*RJ11 - Cat 3 Kablosuz) | 12 | 120 | 215,00 |
| 600-0003XX-222 | kili Nümeris Telefon. Priz (2*RJ11 - Cat 3) | 12 | 120 | 316,50 |
| 600-0003XX-234 | Data + Nümeris (Cat 6 + RJ11 Cat 3) | 12 | 120 | 558,50 |
| 600-0003XX-229 | Tekli Data Prizi (1*RJ45 Cat6) | 12 | 120 | 479,00 |
| 600-0003XX-230 | İkili Data Prizi (2*RJ45 Cat6) | 12 | 120 | 793,50 |
| 600-0003XX-233 | Data Priz (Jaksız) | 12 | 120 | 155,50 |
| 600-0003XX-236 | 1X HDMI Prizi | 12 | 120 | 917,00 |
| 600-0003XX-269 | 2XHDMI Prizi | 12 | 120 | 1.374,50 |
| 600-0003XX-242 | Data + HDMI Prizi | 12 | 120 | 1.565,00 |
| 600-0003XX-244 | Data + USB Data Prizi | 12 | 120 | 1.436,00 |
| 600-0003XX-255 | 1XFiber Optik | 12 | 120 | 369,50 |
| 600-0003XX-270 | 2XFiber Optik | 12 | 120 | 554,50 |
| 600-0003XX-235 | USB Data Prizi | 12 | 120 | 523,50 |

Dimmerler

| | | | | |
|----------------|-------------------------|----|-----|----------|
| 600-0003XX-212 | Dimmer 800W | 12 | 120 | 1.261,00 |
| 600-0003XX-248 | Dimmer 500W (Veavien) | 12 | 120 | 2.037,50 |

Elektronik Ürünler

| | | | | |
|----------------|-------------------------------------|----|-----|----------|
| 600-0003XX-262 | Energy Saver Mikro Switch Gecikmeli | 12 | 120 | 2.143,50 |
| 600-0003XX-263 | Energy Saver Mikro Switch | 12 | 120 | 1.310,00 |
| 200-000100-007 | 11 Pinli 3x10 A Röle | 12 | 120 | 3.770,00 |
| 120-011803-101 | Yan Çizgili Logosuz PVC Kart | 12 | 120 | 278,50 |

600-0002XX-200

XX - Kodu karşılığı: 10 = Silver, 11 = Füme, 12 = Titanyum, 13 = Antrasit, 17 = Metalik Siyah, 18 = Metalik Beyaz, 19 = Mocha Anahtar, priz mekanizmalar, (Mekanizma + Tuş / Kapak) ve (Çerçeve) şeklinde 2 parça olarak satılmaktadır. Farklı "Energy Saver" çeşitleri için lütfen firmamız ile iletişime geçiniz.



GRANO WOODS

Sıva Altı Anahtar ve Priz Serisi Renk ve Çerçeve Seçenekleri



Grano Woods / Masif / Anahtar



Grano Woods / Ceviz / Anahtar



Grano Woods
Çerçeveler

| Referans No | Ürün Adı (Mekanizma + Tuş/Kapak) | Kutudaki Adet | Kolideki Adet | Liste Fiyatı (TL) |
|----------------|----------------------------------|---------------|---------------|---------------------|
| 400-XX0000-096 | Tekli Çerçeve | 12 | 240 | 101,50 |
| 400-XX0000-226 | İkili Çerçeve | 12 | 120 | 151,50 |
| 400-XX0000-227 | Üçlü Çerçeve | 12 | 120 | 181,00 |
| 400-XX0000-228 | Dörtlü Çerçeve | 12 | 120 | 223,50 |
| 400-XX0000-250 | Beşli Çerçeve | 12 | 120 | 285,00 |

400-XX0000-096

XX - Çerçeve kodu karşılığı : 14 = Masif, 15 = Ceviz

Çoklu çerçeveler yatay ve dikey kullanıma uygundur.

Grano serisi, (Mekanizma + Tuş / Kapak) ve (Çerçeve) şeklinde 2 parça olarak satılmaktadır.

GRANO WOODS MEKANİZMA

| Referans No | Ürün Adı (Mekanizma + Tuş/Kapak) | Kutudaki Adet | Kolideki Adet | Liste Fiyatı (TL) |
|----------------------|----------------------------------|---------------|---------------|-------------------|
| Anahtar Grubu | | | | |
| 600-0002XX-200 | Anahtar | 12 | 120 | 169,50 |
| 600-0002XX-202 | Komütatör | 12 | 120 | 208,00 |
| 600-0002XX-205 | Light Anahtarı | 12 | 120 | 173,00 |
| 600-0002XX-204 | Kapı Otomatığı Anahtarı | 12 | 120 | 173,00 |
| 600-0002XX-207 | Zil Anahtarı | 12 | 120 | 173,00 |
| 600-0002XX-209 | Veavien | 12 | 120 | 198,00 |
| 600-0002XX-211 | Komütatör Veavien | 12 | 120 | 268,50 |
| 600-0002XX-214 | Permütatör (Ara Veavien) | 12 | 120 | 224,00 |
| 600-0002XX-254 | Üçlü Anahtar | 12 | 120 | 251,00 |
| 600-0002XX-216 | Jaluzi Kumanda Anahtarı | 12 | 120 | 238,50 |
| 600-0022XX-216 | Yaysız Jaluzi Kumanda Anahtarı | 12 | 120 | 250,00 |
| 600-0002XX-220 | İmpuls Komütatör (Light + Light) | 12 | 120 | 226,00 |
| 600-0002XX-251 | DND/MUR İç Ünite Komütatör | 12 | 120 | 237,00 |
| 600-0002XX-252 | Müzik Yayın Anahtarı | 12 | 120 | 1.380,00 |



Ceviz
600-000215-200



Ceviz
600-000315-218

Led Işıklı Anahtar

| | | | | |
|----------------|-----------------------|----|----|--------|
| 600-0002XX-201 | Işıklı Anahtar | 12 | 60 | 238,50 |
| 600-0002XX-203 | Işıklı Komütatör | 12 | 60 | 294,00 |
| 600-0002XX-206 | Işıklı Light Anahtarı | 12 | 60 | 238,50 |
| 600-0002XX-210 | Işıklı Veavien | 12 | 60 | 278,50 |

Priz Grubu

| | | | | |
|----------------|-------------------------------|----|-----|----------|
| 600-0003XX-217 | Topraklı Priz | 12 | 120 | 185,00 |
| 600-0003XX-218 | Topraklı Priz (1x2x2) | 12 | 120 | 206,50 |
| 600-0003XX-249 | Kapaklı Topraklı Priz | 12 | 120 | 193,50 |
| 600-0003XX-243 | Kapaklı Topraklı Priz (1x2x2) | 12 | 120 | 222,00 |
| 600-0003XX-219 | Ups Topraklı Priz (1x2x2) | 12 | 120 | 253,50 |
| 600-000301-907 | İkili Topraklı Priz (1x2x2) | 12 | 120 | 325,00 |
| 600-0003XX-245 | 1X USB Şarj Prizi 5V-2A | 12 | 120 | 1.581,00 |
| 600-0003XX-247 | 2X USB Şarj Prizi 5V-2A | 12 | 120 | 1.865,50 |

| Referans No | Ürün Adı (Mekanizma + Tug/Kapak) | Kutudaki Adet | Kolideki Adet | Liste Fiyatı (TL) |
|---------------------------------|---|---------------|---------------|---------------------|
| TV - Uydu - Sat Prizleri | | | | |
| 600-0003XX-237 | TV Anten Prizi (Ekranlı Geçişli) | 12 | 120 | 277,00 |
| 600-0003XX-238 | TV Anten Prizi (Ekranlı Sonlu) | 12 | 120 | 277,00 |
| 600-0003XX-231 | Uydu Prizi (Tekli, F Tipi Konnektor, Sonlu) | 12 | 120 | 193,50 |
| 600-0003XX-232 | Uydu Prizi (Tekli, F Tipi Konnektor, Ekranlı) | 12 | 120 | 352,50 |
| 600-0003XX-239 | TV - Sat Prizi, İkili (Geçişli) | 12 | 60 | 1.005,50 |
| 600-0003XX-240 | TV - Sat Prizi, İkili (Sonlu) | 12 | 60 | 1.005,50 |
| 600-0003XX-241 | Kablo Çıkışı | 12 | 60 | 156,50 |

İletişim Priz Grubu

| | | | | |
|----------------|---|----|-----|----------|
| 600-0003XX-221 | Nümeris Telefon Prizi (1*RJ11-623 Kablolu , 4 Kontaklı) | 12 | 120 | 198,50 |
| 600-0003XX-223 | Nümeris Telefon Prizi (1*RJ11 - Cat 3 Kablosuz) | 12 | 120 | 232,00 |
| 600-0003XX-222 | İkili Nümeris Telefon Prizi (2*RJ11 - Cat 3) | 12 | 120 | 340,50 |
| 600-0003XX-234 | Data + Nümeris (Cat 6 + RJ11 Cat 3) | 12 | 120 | 510,50 |
| 600-0003XX-229 | Tekli Data Prizi (1*RJ45 Cat6) | 12 | 120 | 443,00 |
| 600-0003XX-230 | İkili Data Prizi (2*RJ45 Cat6) | 12 | 120 | 789,00 |
| 600-0003XX-233 | Data Priz (Jaksız) | 12 | 120 | 191,50 |
| 600-0003XX-236 | 1X HDMI Prizi | 12 | 120 | 930,50 |
| 600-0003XX-269 | 2XHDMI Prizi | 12 | 120 | 1.392,00 |
| 600-0003XX-242 | Data + HDMI Prizi | 12 | 120 | 1.461,50 |
| 600-0003XX-244 | Data + USB Data Prizi | 12 | 120 | 1.334,00 |
| 600-0003XX-255 | 1XFiber Optik | 12 | 120 | 336,50 |
| 600-0003XX-270 | 2XFiber Optik | 12 | 120 | 504,50 |
| 600-0003XX-235 | USB Data Prizi | 12 | 120 | 616,00 |

Dimmerler

| | | | | |
|----------------|-------------------------|----|-----|----------|
| 600-0003XX-212 | Dimmer 800W | 12 | 120 | 1.253,00 |
| 600-0003XX-248 | Dimmer 500W (Veavien) | 12 | 120 | 2.007,00 |

Elektronik Ürünler

| | | | | |
|----------------|-------------------------------------|----|-----|----------|
| 600-0003XX-262 | Energy Saver Mikro Switch Gecikmeli | 12 | 120 | 2.111,00 |
| 600-0003XX-263 | Energy Saver Mikro Switch | 12 | 120 | 1.328,00 |
| 200-000100-007 | 11 Pinli 3x10 A Röle | 12 | 120 | 3.770,00 |
| 120-011803-101 | Yan Çizgili Logosuz PVC Kart | 12 | 120 | 278,50 |



SIVAÜSTÜ NİVO
FİYATLARI

| Referans No | Ürün Adı (Mekanizma + Tuş/Kapak) | Kutudaki Adet | Kolideki Adet | Liste Fiyatı (TL) |
|-------------|----------------------------------|---------------|---------------|-------------------|
|-------------|----------------------------------|---------------|---------------|-------------------|

Anahtar Grubu

| | | | | |
|----------------|------------------------|----|-----|--------|
| 402-010000-200 | Anahtar | 12 | 120 | 101,00 |
| 402-010000-202 | Komütatör | 12 | 120 | 119,50 |
| 402-010000-205 | Light Anahtar | 12 | 120 | 104,00 |
| 402-010000-204 | Kapı Otomatığı Anahtar | 12 | 120 | 104,00 |
| 402-010000-207 | Zil Anahtar | 12 | 120 | 104,00 |
| 402-010000-209 | Veavien | 12 | 120 | 117,00 |
| 402-010000-254 | Üçlü Anahtar | 12 | 120 | 164,00 |

Priz Grubu

| | | | | |
|----------------|-----------------------|----|-----|--------|
| 402-010000-217 | Topraklı Priz | 12 | 120 | 121,00 |
| 402-010000-218 | Topraklı Priz | 12 | 120 | 144,00 |
| 402-010000-243 | Kapaklı Topraklı Priz | 12 | 120 | 152,50 |
| 402-010000-249 | Kapaklı Topraklı Priz | 12 | 72 | 133,50 |

TV - Uydu - Sat Prizleri

| | | | | |
|----------------|---|----|-----|--------|
| 402-010000-231 | Uydu Prizi (Tekli, F Tipi Konnektör, Sırlı) | 12 | 120 | 136,50 |
|----------------|---|----|-----|--------|

İletişim Priz Grubu

| | | | | |
|----------------|--|----|-----|--------|
| 402-010000-221 | Numaralı Telefon Priz (1*811-6238, 4 Kontaklı) | 12 | 120 | 121,00 |
|----------------|--|----|-----|--------|

Kombine Ürünler

| | | | | |
|----------------|-----------------------------------|----|----|--------|
| 402-010000-910 | Anahtar + Topraklı Priz | 12 | 72 | 200,00 |
| 402-010000-912 | Komütatör + Topraklı Priz | 12 | 72 | 212,50 |
| 402-010000-914 | Anahtar + Kapaklı Topraklı Priz | 12 | 72 | 206,00 |
| 402-010000-915 | Komütatör + Kapaklı Topraklı Priz | 12 | 72 | 221,00 |

2'Li Topraklı Grup Prizler

Referans No

Ürün Adı

Kolideki Adet

Liste Fiyatı (TL)



| | | | |
|----------------|-------------------------------|----|--------|
| 700-000000-112 | İkili Topraklı Priz Klemensli | 72 | 162,50 |
| 700-000150-112 | İkili Topraklı Priz 1,5mt | 12 | 414,00 |
| 700-000300-112 | İkili Topraklı Priz 3mt | 12 | 559,50 |
| 700-000500-112 | İkili Topraklı Priz 5mt | 12 | 796,00 |

3'Lü Topraklı Grup Prizler



| | | | |
|----------------|------------------------------|----|--------|
| 700-000000-113 | Üçlü Topraklı Priz Klemensli | 60 | 220,00 |
| 700-000150-113 | Üçlü Topraklı Priz 1,5mt | 12 | 471,50 |
| 700-000300-113 | Üçlü Topraklı Priz 3mt | 12 | 602,50 |
| 700-000500-113 | Üçlü Topraklı Priz 5mt | 12 | 834,00 |

Anahtarlı



| | | | |
|----------------|--|----|---------|
| 700-000000-123 | Üçlü Topraklı Anahtarlı Priz Klemensli | 48 | 572,00 |
| 700-000150-123 | Üçlü Topraklı Anahtarlı Priz 1,5mt | 15 | 823,50 |
| 700-000300-123 | Üçlü Topraklı Anahtarlı Priz 3mt | 15 | 911,00 |
| 700-000500-123 | Üçlü Topraklı Anahtarlı Priz 5mt | 12 | 1080,00 |

4'Lü Topraklı Grup Prizler



| | | | |
|----------------|--------------------------------|----|--------|
| 700-000000-114 | Dörtlü Topraklı Priz Klemensli | 42 | 279,50 |
| 700-000150-114 | Dörtlü Topraklı Priz 1,5mt | 15 | 529,00 |
| 700-000300-114 | Dörtlü Topraklı Priz 3mt | 15 | 640,50 |
| 700-000500-114 | Dörtlü Topraklı Priz 5mt | 12 | 867,00 |

Anahtarlı



| | | | |
|----------------|--|----|---------|
| 700-000000-124 | Dörtlü Topraklı Anahtarlı Priz Klemensli | 40 | 633,00 |
| 700-000150-124 | Dörtlü Topraklı Anahtarlı Priz 1,5mt | 15 | 884,00 |
| 700-000300-124 | Dörtlü Topraklı Anahtarlı Priz 3mt | 15 | 970,00 |
| 700-000500-124 | Dörtlü Topraklı Anahtarlı Priz 5mt | 12 | 1142,00 |

6'Li Topraklı Grup Prizler



| | | | |
|----------------|--------------------------------|----|--------|
| 700-000000-116 | Altılı Topraklı Priz Klemensli | 36 | 398,50 |
| 700-000150-116 | Altılı Topraklı Priz 1,5mt | 15 | 647,50 |
| 700-000300-116 | Altılı Topraklı Priz 3mt | 15 | 732,00 |
| 700-000500-116 | Altılı Topraklı Priz 5mt | 12 | 949,50 |

Anahtarlı



| | | | |
|----------------|--|----|----------|
| 700-000000-126 | Altılı Topraklı Anahtarlı Priz Klemensli | 32 | 747,50 |
| 700-000150-126 | Altılı Topraklı Anahtarlı Priz 1,5mt | 15 | 996,00 |
| 700-000300-126 | Altılı Topraklı Anahtarlı Priz 3mt | 15 | 1.080,50 |
| 700-000500-126 | Altılı Topraklı Anahtarlı Priz 5mt | 12 | 1.253,00 |

**2'li Çocuk Korumalı
Topraklı Grup Prizler**

Referans No

Ürün Adı

Kolideki Adet

Liste Fiyatı (TL)



| | | | |
|----------------|---|----|--------|
| 700-000000-312 | İkili Çocuk.kor Topraklı Priz Klemensli | 72 | 164,00 |
| 700-000150-312 | İkili Çocuk.kor Topraklı Priz 1,5mt | 12 | 416,00 |
| 700-000300-312 | İkili Çocuk.kor Topraklı Priz 3mt | 12 | 572,50 |
| 700-000500-312 | İkili Çocuk.kor Topraklı Priz 5mt | 12 | 808,50 |

**3'lü Çocuk Korumalı
Topraklı Grup Prizler**

| | | | |
|----------------|--|----|--------|
| 700-000000-313 | Üçlü Çocuk.kor Topraklı Priz Klemensli | 60 | 222,50 |
| 700-000150-313 | Üçlü Çocuk.kor Topraklı Priz 1,5mt | 12 | 474,50 |
| 700-000300-313 | Üçlü Çocuk.kor Topraklı Priz 3mt | 12 | 620,00 |
| 700-000500-313 | Üçlü Çocuk.kor Topraklı Priz 5mt | 12 | 851,50 |

Anahtarlı

| | | | |
|----------------|--|----|----------|
| 700-000000-323 | Üçlü Çocuk.kor Topraklı Anahtarlı Priz Klemensli | 48 | 577,00 |
| 700-000150-323 | Üçlü Çocuk.kor Topraklı Anahtarlı Priz 1,5mt | 15 | 826,50 |
| 700-000300-323 | Üçlü Çocuk.kor Topraklı Anahtarlı Priz 3mt | 15 | 912,00 |
| 700-000500-323 | Üçlü Çocuk.kor Topraklı Anahtarlı Priz 5mt | 12 | 1.084,00 |

**4'lü Çocuk Korumalı
Topraklı Grup Prizler**

| | | | |
|----------------|--|----|--------|
| 700-000000-314 | Dörtlü Çocuk.kor Topraklı Priz Klemensli | 42 | 283,50 |
| 700-000150-314 | Dörtlü Çocuk.kor Topraklı Priz 1,5mt | 15 | 532,50 |
| 700-000300-314 | Dörtlü Çocuk.kor Topraklı Priz 3mt | 15 | 663,00 |
| 700-000500-314 | Dörtlü Çocuk.kor Topraklı Priz 5mt | 12 | 889,00 |

Anahtarlı

| | | | |
|----------------|--|----|----------|
| 700-000000-324 | Dörtlü Çocuk.kor Topraklı Anahtarlı Priz Klemensli | 40 | 638,50 |
| 700-000150-324 | Dörtlü Çocuk.kor Topraklı Anahtarlı Priz 1,5mt | 15 | 888,00 |
| 700-000300-324 | Dörtlü Çocuk.kor Topraklı Anahtarlı Priz 3mt | 15 | 974,00 |
| 700-000500-324 | Dörtlü Çocuk.kor Topraklı Anahtarlı Priz 5mt | 12 | 1.145,50 |

**6'lı Çocuk Korumalı
Topraklı Grup Prizler**

| | | | |
|----------------|--|----|--------|
| 700-000000-316 | Altılı Çocuk.kor Topraklı Priz Klemensli | 36 | 403,50 |
| 700-000150-316 | Altılı Çocuk.kor Topraklı Priz 1,5mt | 15 | 652,50 |
| 700-000300-316 | Altılı Çocuk.kor Topraklı Priz 3mt | 15 | 749,00 |
| 700-000500-316 | Altılı Çocuk.kor Topraklı Priz 5mt | 12 | 976,50 |

Anahtarlı

| | | | |
|----------------|--|----|----------|
| 700-000000-326 | Altılı Çocuk.kor Topraklı Anahtarlı Priz Klemensli | 32 | 753,50 |
| 700-000150-326 | Altılı Çocuk.kor Topraklı Anahtarlı Priz 1,5mt | 15 | 1.001,50 |
| 700-000300-326 | Altılı Çocuk.kor Topraklı Anahtarlı Priz 3mt | 15 | 1086,50 |
| 700-000500-326 | Altılı Çocuk.kor Topraklı Anahtarlı Priz 5mt | 12 | 1.258,00 |

SIVAALTI SIGORTA KUTUSU



EK APARAT

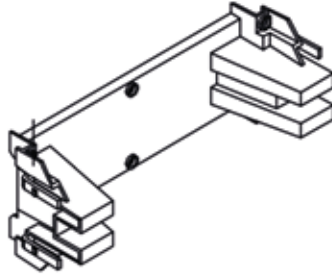

RAY

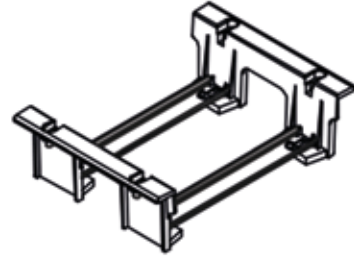

$$24_M + 24_M = 48_M$$

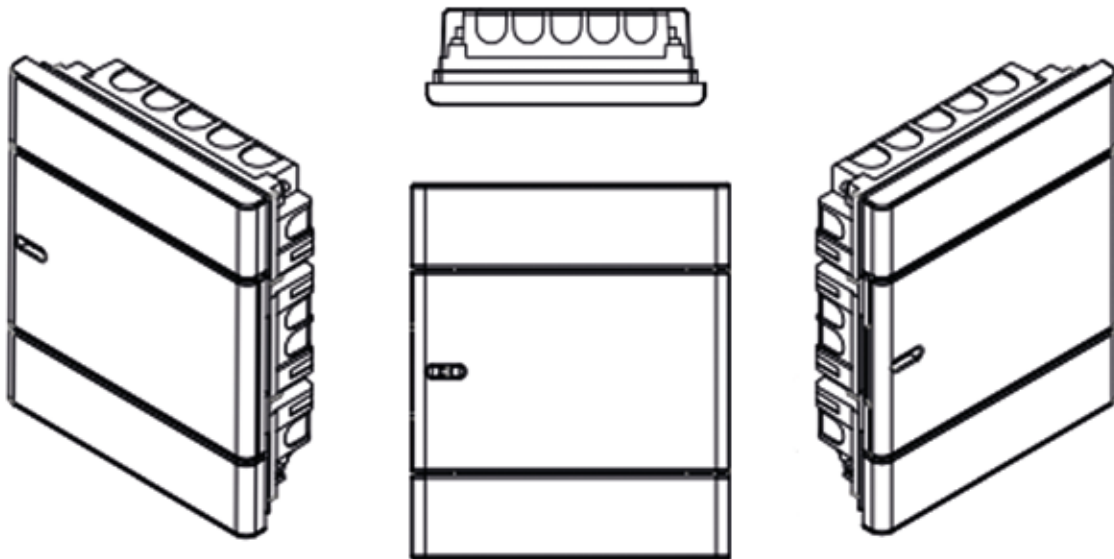

halogen
free

+60 C
-20 C

termoplast

IP40



SIVAALI SİGORTA KUTUSU

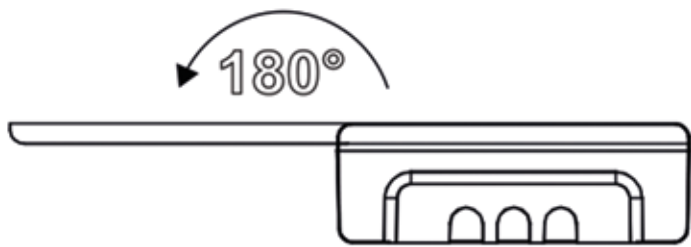
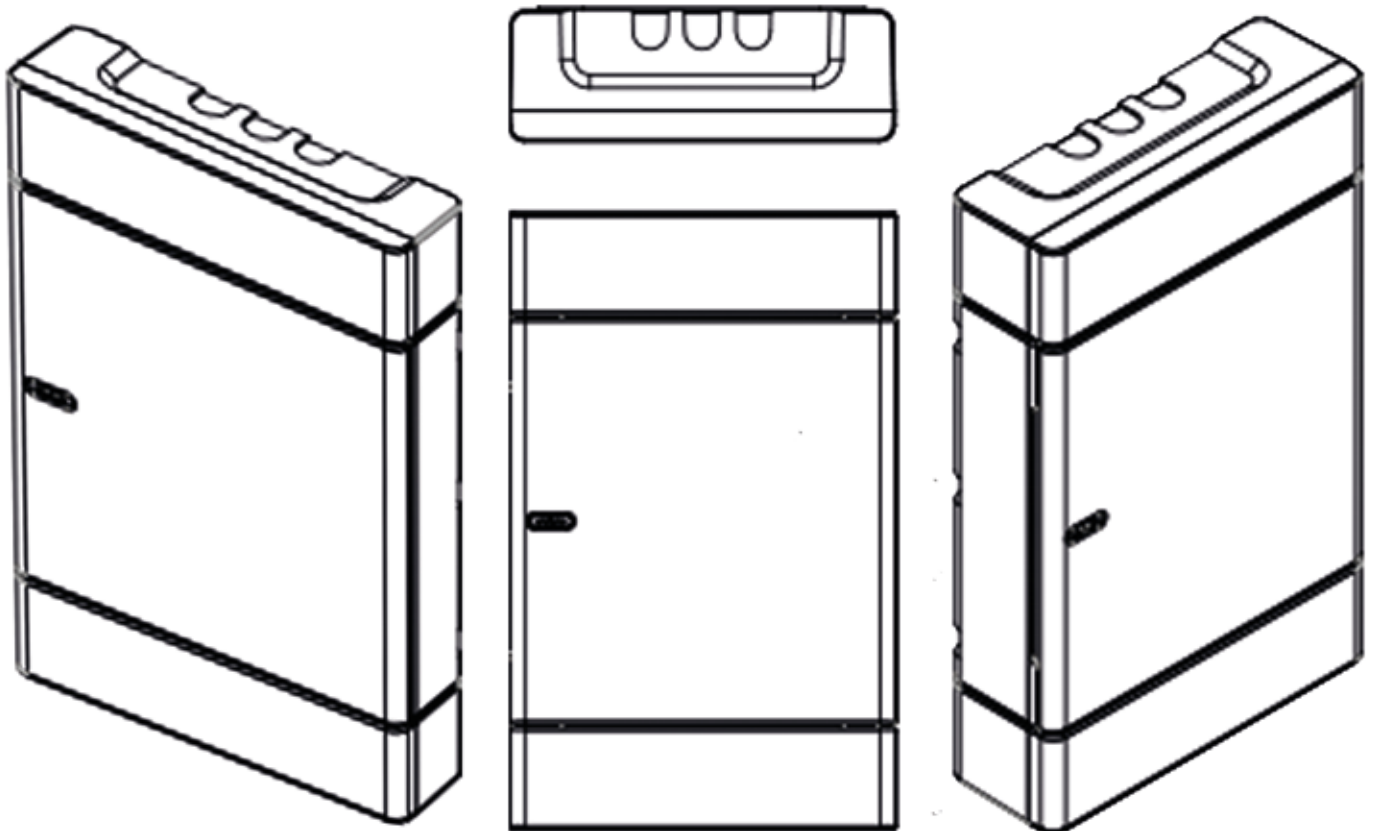

| | | | |
|-----------------|----------------|------------|---|
| halogen free | +60 C -20 C | termoplast | IP40  |
|-----------------|----------------|------------|---|

Sigorta Kutuları Sıva Altı



4'lü Sıva Altı,
Sigorta Kutusu



6'li Sıva Altı,
Sigorta Kutusu



8'li Sıva Altı,
Sigorta Kutusu



12'li Sıva Altı,
Sigorta Kutusu



18'li Sıva Altı,
Sigorta Kutusu



24'lü Sıva Altı,
Sigorta Kutusu



36'lı Sıva Altı,
Sigorta Kutusu

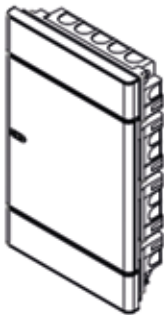

Referans No

Ürün Adı

Liste Fiyatı
(TL)

| | | |
|----------------|--------------------------------|----------|
| 330-010200-004 | 4'lü Sıva Altı Sigorta Kutusu | 351,50 |
| 330-010200-006 | 6'li Sıva Altı Sigorta Kutusu | 462,50 |
| 330-010200-008 | 8'li Sıva Altı Sigorta Kutusu | 541,00 |
| 330-010200-012 | 12'li Sıva Altı Sigorta Kutusu | 715,50 |
| 330-010200-018 | 18'li Sıva Altı Sigorta Kutusu | 896,00 |
| 330-010200-024 | 24'lü Sıva Altı Sigorta Kutusu | 1.115,50 |
| 330-010200-036 | 36'lı Sıva Altı Sigorta Kutusu | 1.707,50 |
| 330-010200-048 | 48'li Sıva Altı Sigorta Kutusu | 2.286,50 |
| 330-010200-072 | 72'li Sıva Altı Sigorta Kutusu | 3.419,50 |

Sigorta Kutuları Sıva Üstü



4'lü Sıva Üstü,
Sigorta Kutusu



6'li Sıva Üstü,
Sigorta Kutusu



8'li Sıva Üstü,
Sigorta Kutusu



12'li Sıva Üstü,
Sigorta Kutusu



18'li Sıva Üstü,
Sigorta Kutusu



24'li Sıva Üstü,
Sigorta Kutusu



36'li Sıva Üstü,
Sigorta Kutusu

Sıva Üstü Sigorta Kutuları



| Referans No | Ürün Adı | Liste Fiyatı (TL) |
|----------------|--------------------------------|-------------------|
| 330-010100-004 | 4'lü Sıva Üstü Sigorta Kutusu | 362,50 |
| 330-010100-006 | 6'lı Sıva Üstü Sigorta Kutusu | 461,50 |
| 330-010100-008 | 8'li Sıva Üstü Sigorta Kutusu | 558,50 |
| 330-010100-012 | 12'li Sıva Üstü Sigorta Kutusu | 753,50 |
| 330-010100-018 | 18'li Sıva Üstü Sigorta Kutusu | 1.007,00 |
| 330-010100-024 | 24'li Sıva Üstü Sigorta Kutusu | 1.070,50 |
| 330-010100-036 | 36'lı Sıva Üstü Sigorta Kutusu | 1.625,00 |

Aksesuar
Grubu

701-000000-003



701-000000-001



701-000000-004



701-000000-002



701-000000-005



701-000000-006

Fişler

Referans No

Ürün Adı

Kutudaki
AdetKolideki
AdetListe Fiyatı
(TL)

| | | | | |
|----------------|-----------------------|----|-----|--------|
| 701-000000-001 | Dişi Fiş Topraklı | 50 | 400 | 98,50 |
| 701-000000-002 | Erkek Fiş Topraklı | 40 | 400 | 74,00 |
| 701-000000-003 | Kulplu Fiş Topraklı | 40 | 400 | 74,00 |
| 701-000000-004 | Monoblok Fiş Topraklı | 40 | 400 | 74,00 |
| 701-000000-006 | 2 Li Golyad | 12 | 72 | 210,50 |
| 701-000000-005 | 3 Lü Golyad | 12 | 96 | 284,00 |

ovivo

ELECTRIC

Hakkımızda

- 1987 - Hırdavat malzemeleri satmak üzere İstanbul'da kuruldu.
- 1993 - Portföyüne elektrik malzemeleri de ilave ederek ürün yelpazesini genişletti.
- 1996 - ELBI markasıyla Anahtar - Priz üretimine başladı.
- 2002 - Arnavutköy fabrikası açıldı.
- 2007 - Finlandiya'lı Ahlström Capital ile ortaklık anlaşması imzaladı.
- 2009 - BDY Elektrik (OVIVO) Aydınlatma fabrikası kuruldu.
- 2012 - Ahlström Capital'e ELBI hisseleri devredildi.
- 2015 - Arnavutköy yeni üretim tesislerine taşındı.
- 2016 - Tamamen yeni ve farklı tasarımlarla tekrar OVIVO markasıyla Anahtar - Priz üretimine başladı.

Misyonumuz

Ürünlerini uluslararası kalite standartlarında, farklı tasarımlarla, güvenliği öncelik olan modellerle ve rekabetçi fiyatlarla üreterek sektöründe güçlü bir dünya markası olmak.

Vizyonumuz

Yurt içi ve yurt dışı pazarlarda aranan lider bir Türkiye markası olmak.

Prensiplerimiz

- Müşteri Memnuniyeti: Her şey müşterilerimizin memnuniyeti için.
- Yurt içi ve yurt dışında satış ve sonrası hizmetlerde maksimum memnuniyet sağlamak ana prensibimizdir.
- Ürün Güvenliği: Uluslararası standartlarda ailemizin güvenliğini sağlayan ürünler üretiliyor.
- Kalite: Başarımızın arkasında uluslararası standartlarda üretim ve hizmette maksimum kaliteyi sunma yattıyor.
- Çalışanlarımız: Mutfağımızın ustaları. Hepsisi ailemizin birer ferdi. Gücümüzü onların müthiş performanslarından alıyoruz.
- Tasarım: İnovatif ve farklı tasarım ürünlerimiz ile görsellik ve kullanım rahatlığı ve farkındalığı sağlamayı hedefledik.
- İş Güvenliği: Çalışanlarımızın güvenli, sağlıklı ve keyifli bir ortamda çalışmalarını ile maksimum verimliliğini hedefliyoruz.

YENİ ÜRÜN
HEYECAN



www.ovivoelektrik.com.tr

